

# Extension unit Control 70

Instructions for Initial Operation

Copyright.  
No part of this manual may be reproduced without our prior written approval.  
We reserve the right to alter details in the interest of progress.

Status: 10.2006  
#8 009 532

1 - GB 360102 - M - 0.5 - 1197

Marantec 

## Figure of the extension unit Control 70

### Control elements and display:

1. Display for function and error messages
2. PROGRAMMING button
3. PLUS button
4. MINUS button

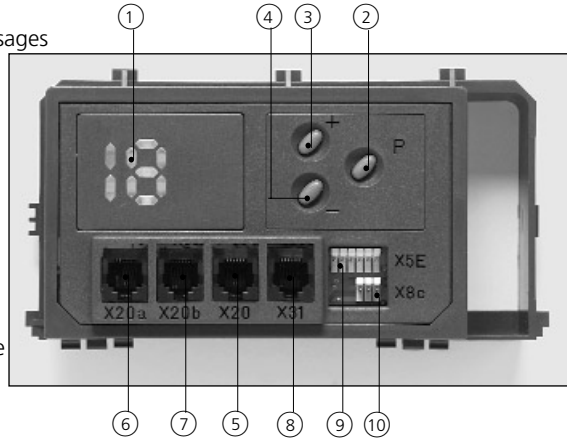

### Plug connections:

5. X20 External photocell (to monitor through-traffic area)
6. X20a Roll-up safety device
7. X20b Electronic aerial
8. X31 Closing edge safety device (SKS)
9. X5E Button connection-circuit board
10. X8c Traffic light controls, relay circuit board 2

### Variations:

- Item no. 48 077 Extension unit for SKS  
 Item no. 48 079 Extension unit for SKS and roll-up safety device (**Extension unit**)

## Explanation of Symbols

### Symbols used in these instructions:



#### WARNUNG

Important safety advice which must be followed in order to prevent injury to persons or damage to property.



**Installation instructions** regarding mechanical or electrical connection.



#### Programming instructions

After connecting the function or control element, the control unit must be programmed.



#### Operational check

After connecting and programming the function or control elements, the function of the control unit must be checked.



#### Wiring schemes and circuit diagrams

## Notes

6.3 Test instructions

Fault	Message	Cause	Remedy
No response after impulse.	Luminous bar "error message" flashing. Error message 0	Control unit is locked (red mark). Static current circuit (control elements) broken Static current circuit (door leaf) broken.	Unlock control unit (blue mark) see instructions "Control 70 control unit". Check static current circuit of closing edge safety device.
Door can be opened only	Luminous bar "error message" flashing. Error message 15	External photocell programmed but not connected.	Connect photocell and align or check programming of photocell (menu 7/menu 8).
Door can be closed only	Luminous bar "error message" flashing. Error message 15	Roll-up safety device	Connect roll-up safety device, check connection. Check that transmitter and receiver are properly aligned and side assigned. Align transmitter and receiver in such a way that the LEDs H1 to H3 of the LS expander (see chapter 4.3) glow when the door is not at its CLOSE travel limit.
Door can only be closed in dead man's mode.	Luminous bar "error message" flashing. Error message 13	Closing edge safety device	No visual contact between transmitter and receiver bungs. Bottom door seal defective Closing edge safety device defective/incorrectly fitted.
No response to remote control	None	Electronic aerial not plugged in. Transmitter not connected Wrong hand transmitter coding programmed. Flat battery in hand transmitter.	Connect aerial (see chapter 4.1/4.2) Programme the remote control (see chapter 5.4 or documentation supplied with remote control). Insert new battery (9V, IEC 6F22 or 12V, A 23)

Chapter	page
<b>Figure of the extension unit Control 70</b>	2
<b>Explanation of Symbols</b>	2
<b>1. Contents</b>	3
<b>2. Important! Read carefully before carrying out any work!</b>	4
<b>3. Initial Operation of the extension unit Control 70</b>	
3.1 Connecting the extension unit Control 70	5
3.2 Connecting the closing edge safety device (SKS)	6
<b>4. Connection and Initial Operation of Accessories</b>	
4.1 Remote control with system plug	8
4.2 Remote control without system plug	8
4.3 External photocell	8
4.4 Roll-up safety device (extension unit)	10
4.5 Button connection-circuit board	12
4.6 Traffic light controls Control 313	13
<b>5. Programming the Extension unit Control 70</b>	
5.1 General information	15
5.2 Display of status messages	16
5.3 Display of error numbers	17
5.4 Menu 1: Programming the remote control	18
5.5 Menu 2: Operating modes "OPEN/CLOSE press-and-release"	19
5.6 Menu 3: Operating modes "button functions"	19
5.7 Menu 4: Automatic timer "OPEN PHASE"	20
Menu 5: Automatic timer "WARNING PHASE"	20
5.8 Menu 6: Start-up warning	21
5.9 Menu 7: Closing after passing the external photocell	21
5.10 Menu 8: Response after activation of the external photocell	22
5.11 Menu 9: Response after activation of the closing edge safety device	22
5.12 Menu 10: Signal lights	23
5.13 Menu 11: ON/OFF traffic lane control	23
5.14 Menu 12: Special functions	24
5.15 Menu 13: Door cycle counter display	25
<b>6. Appendix</b>	
6.1 Overview of the programming menus	26
6.2 Connection plan of the extension unit Control 70	28
6.3 Test instructions	30

## 2. Important! Read carefully before carrying out any work!



Only connect this control unit if you are a

### Qualified Electrician

or if you

### have been instructed or supervised by a qualified electrician and in particular

- are aware of the hazards associated with electricity
- are familiar with the relevant electro-technical regulations
- are able to use and maintain safety equipment
- know when and how to perform first aid

Before carrying out any work on the electrical system of the door, disconnect the control unit from the mains supply!

Observe the local safety regulations!

Always lay the mains cable and control cable separately!

Never feed cable into the top end of the control unit!

Never press more than one control unit button at any one time!



### Before moving the door to carry out adjustments, ensure that neither persons nor objects are located within the door's area of operation

#### Installation for protection category IP 65:

- At the very latest after initial operation, replace the plug-in mains connection with a permanent direct mains connection.
- It is essential that a mains isolator switch is fitted.

Only ever operate the door in dead man's mode (press-and-hold) provided you have a full view of the door's entire area of operation from all control elements.

#### Only ever activate the "OPEN PRESS-AND-RELEASE" function provided:

- the opening door does not present a hazard.  
(This condition is met if persons and objects cannot be struck by the door and/or caught/drawn up in the door).

or if:

- you have installed and activated a **suitable roll-up safety device**.  
**For rolling grilles, this device is absolutely essential!**

#### After initial operation of the door:

- Check all the emergency command devices.
- Show those persons responsible for operating the door system (or their representatives) how the door system works.



**Should you fail to comply with these warning and safety instructions, you will be responsible for any injury to persons or damage to property resulting therefrom!**

## 6. Appendix

### Legend:

### Buttons:

S2P	Plus button
S3P	Programme button
S4P	Minus button

### Plug connections:

X20	External photocell, CLOSE direction
X20a	Roll-up safety device
X20b	Electronic aerial
X31	Closing edge safety device (SKS)
X5	Base circuit board
X5E	Button connection-circuit board
X8c	Traffic light controls - relay circuit board 2

### Variations

Item no. 48 077

Extension unit for SKS  
Item no. 48 079  
Extension unit for SKS and roll-up safety device (extension unit)

### 6.2 Connection plan of the extension unit Control 70

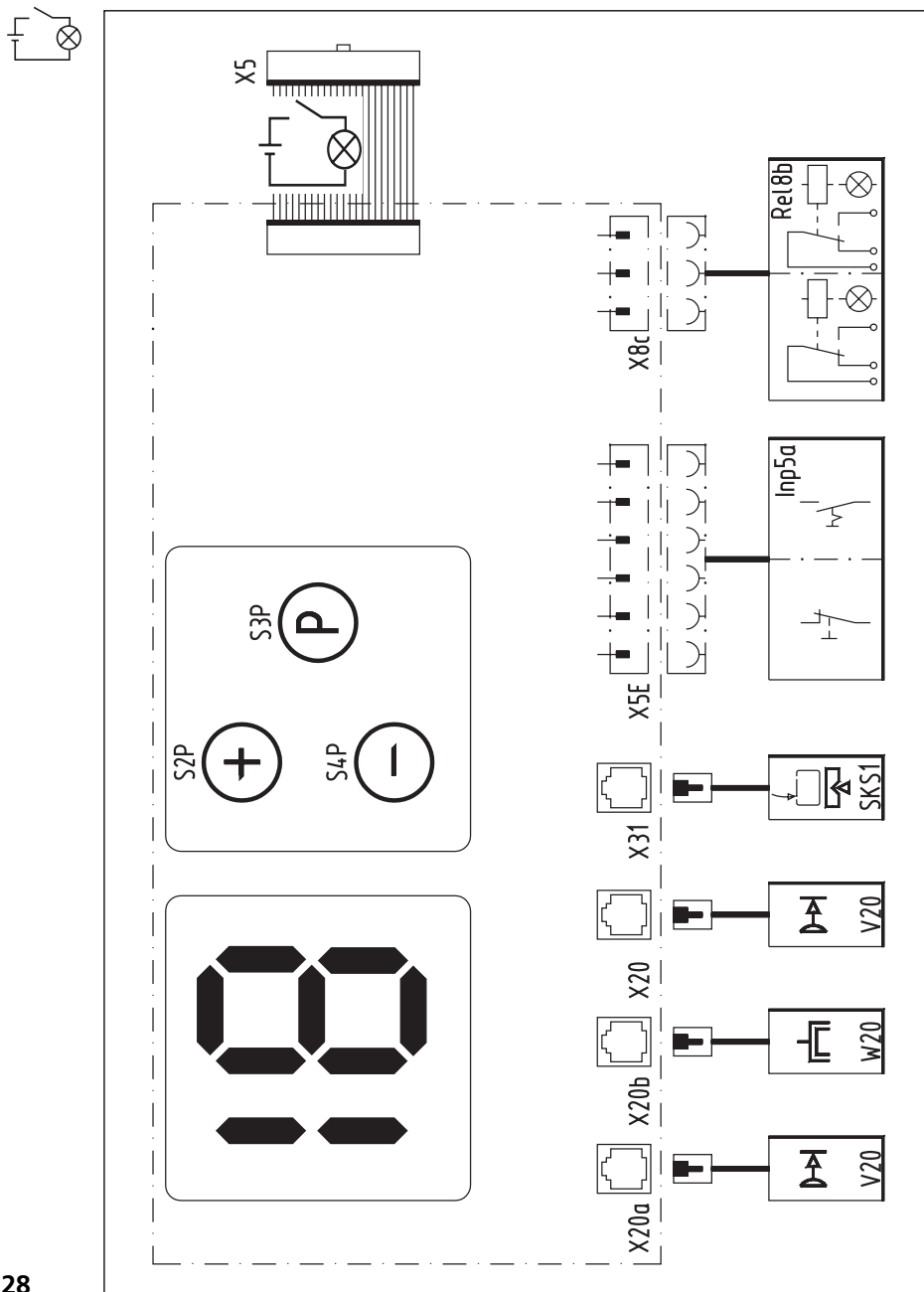

### 3.1 Connecting the extension unit Control 70

#### General information:

The extension unit increases the function range of the **Control 70 base control unit with dead man's control**. It offers the following performance features:

- Self-checking of the safety and function elements prior to every door movement
- Door closing also by press-and-release (closing edge safety device required)
- Monitoring of the roll-up area during the opening phase, e.g. for rolling grilles (roll-up safety device required)
- Monitoring of the door's through-traffic area during the closing phase (external photocell required)
- Special functions, e.g. automatic timer with programmable open and warning phases
- Integral traffic lane control (traffic light control Control 313 required)
- Simple adjustment of all operating parameters via programming menus
- Remote controlled operation of the door (electronic aerial required)

#### Initial operation:

1. Disconnect the control unit from the mains supply.
2. Connect the extension unit to socket **X5** of the base control unit via the flat cable, in doing so ensuring that the plug is correctly poled.
3. Insert the extension unit into the subrack of the base control unit.
4. Now connect the function and control elements as described below:

#### Note:

**The extension unit Control 70 features a static current circuit. If the static current circuit is broken, this immobilises power operation of the door.**

Elements within this static current circuit include the static current circuit on the door leaf as well as all STOP buttons and safety switches.

### 3. Initial operation of the extension unit Control 70

#### 3.2 Connecting the closing edge safety device (SKS)

SKS, RH side connection, item no. 47 016  
 SKS, LH side connection, item no. 47 017

**Function:** The closing edge safety device (SKS) monitors the bottom door seal. If closing the door it encounters an obstruction, the SKS automatically halts the door and then opens it to clear the obstruction.

Connect the SKS to socket **X31** (p. 2, pos. 8) in the control unit.

**Make sure that you fit screw (M) onto the bottom door seal (earth).**

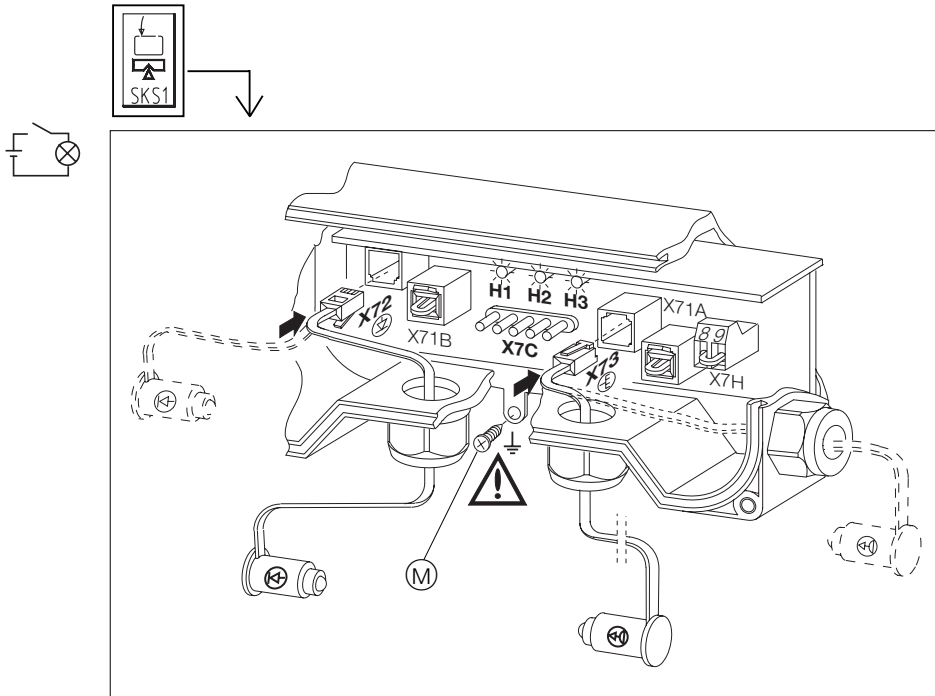

**Legend:**

- X7C Connection of coiled cable (to control unit)
- X72 Optosensor - receiver
- X73 Optosensor - transmitter
- M Screw

### 6. Appendix

Menu (Perm.light)	Function (Display flashing)	Val.	Explanation
5	<b>Automatic timer WARNING PHASE</b>	0	<b>non-active</b>
		1	2 s
		2	5 s
		3	10 s
		4	15 s
		5	20 s
		6	25 s
		7	30 s
		8	35 s
		9	40 s
		10	45 s
		11	50 s
		12	55 s
		13	60 s
		14	65 s
15	70 s		
6	<b>Start-up warning (flashing prior to door movement)</b>	0*	<b>0 s</b>
		1	1 s
		2	2 s
		3	3 s
		4	4 s
		5	5 s
		6	6 s
7	7 s		
7	<b>Closing after passing the external photocell</b>	0*	No
		1	Yes
8	<b>Response after actuation of the external photocell</b>	0	Stop
		1	Short reverse
		2	Long reverse
		3*	Photocell not fitted
4	Automatic timer without photocell		
9	<b>Impulse after activating safety edge system</b>	0	Stop
		1*	Short reverse
		2	Long reverse
10	<b>Signal lights</b>	0	Permanent light
		1	Flashing
11	<b>Traffic lane control</b>	0*	Traffic lane control non-active
		1	Traffic lane control active
12	<b>Special function</b>	0*	No special function
		1	Central control operating mode
		2	Master function operating mode
13	<b>Display of door cycle counter</b>		Digits 1 - 5

## 6. Appendix

### 6.1 Overview of programming manus

Menu (Perm.light)	Function (Display flashing)	Val.	Explanation		
<b>Status display</b>	<b>Display of error numbers</b>	0	STOP circuit opened		
		5	SKS actuated		
		6	Photocell/roll-up safety device actuated		
		7	Programming mode aborted		
		11	Excess travel stop		
		13	Faulty self-check on SKS		
		15	Faulty self-check on roll-up safety device/ext. photocell		
<b>1</b>	<b>Remote control</b>	0*	Entry code		
		1	Exit code		
			P < 2 secs. => QUIT P > 2 secs. => LEARN P > 5 secs. => DELETE		
<b>2</b>	<b>OPEN/CLOSE press-and-release</b>		OPEN direction		
			CLOSE direction		
		0	Dead man's control		
		1	Press-and-release		
		2	Dead man's control		
<b>3</b>	<b>Button functions</b>		Direction buttons		
			Impulse buttons		
			no stop		
			stop		
			no stop		
	stop				
		0	x	x	
		1	x		x
		2		x	x
		3*		x	x
<b>4</b>	<b>Automatic timer: OPEN PHASE</b>	0*	non-active		
		1	5 s		
		2	10 s		
		3	15 s		
		4	20 s		
		5	25 s		
		6	30 s		
		7	<b>35 s</b>		
		8	<b>40 s</b>		
		9	<b>50 s</b>		
		10	<b>80 s</b>		
		11	<b>100 s</b>		
		12	<b>120 s</b>		
		13	<b>150 s</b>		
		14	<b>180 s</b>		
15	<b>250 s</b>				

\* Factory setting

## 3. Initial operation of the extension unit Control 70

### Indicators on the optosensor circuit board:

H1 GREEN LED:	Voltage o.k.
H2 YELLOW LED:	Static current circuit closed (goes out if transmitter not connected)
H3 RED LED:	Optosensor function indicator (goes out if light path interrupted or on transmitter/receiver malfunction)



### Operational check of the closing edge safety device:

- Switch the unit on.
- Operate the door to open approx. 2 metres.
- Press the CLOSE button.  
⇒ **The door should close by press-and-release.**  
— If this is not the case, check the optosensor (refer to chapter 6.3 of the test instructions)
- Whilst the door is still closing, press the bottom door seal together  
⇒ **The door should come to a halt and then rise a short distance.**  
— If this is not the case, check the optosensor (refer to chapter 6.3 of the test instructions)
- Switch the unit off.

### Test instructions for optosensors:

1. Interrupt the light path in the bottom door seal by:
  - pressing the bottom door seal together
  - removing the transmitter or receiver bung
 ⇒ It is no longer possible to close the door by press-and-release.
2. Make the light path clear again or refit the transmitter/receiver bung.  
⇒ It is now once more possible to close the door by press-and-release.

**The operational safety of the closing edge safety device should be tested at least once a year on an operable door !**

## 4. Connection and Initial Operation of Accessories

### 4.1 Remote control with system plug

**Connecting the electronic aerial** Digital 162, item no. 151 198



1. Connect the electronic aerial to socket **X20b** (p. 2, pos. 7) in the control unit.
2. Align the aerial to achieve the best possible range.  
(Note: metal parts have a major screening effect.)

#### Adapting the control unit to a hand transmitter

Follow the instructions in menu 1: Programming the remote control (chapter 5.4).

**Note:**

Your Marantec hand transmitter can be individually coded. Adjustment is carried out via the code switches in the Marantec hand transmitter.



#### Operational check:

- Operate the hand transmitter from a distance of approx. 15 m.  
⇒ **The door should open or close.**  
If this is not the case, repeat the programming of the control unit

### 4.2 Remote control without system plug

Connect the receiver to terminal block X2c of the base control unit. Details can be found in the documentation supplied with the respective remote control.

### 4.3 External photocell

**Function:** The external photocell monitors the door's through-traffic area. If the closing door encounters an obstruction in this area, it automatically re-opens. If the automatic timer is switched on, the OPEN phase stops and then restarts as soon as the photocell is clear.

**When the door is closed, all the photocells are switched off. To adjust the photocells you must therefore fully or partially open the door.**

## 5. Programming the extension unit Control 70

### 5.15 Menu 13: Display of door cycle counter

After selecting this menu, the status of the 5-digit door cycle counter is displayed. The door cycle counter counts the closing cycles of the door system.

The five digits appear one after the other flashing rapidly, separated by a short pause.

**Example:**

The door registers **32,614** closing cycles:

1st flashing sequence          digit 10,000:          display shows **3**

Pause

2nd flashing sequence          digit 1,000:          display shows **2**

Pause

3rd flashing sequence          digit 100:          display shows **6**

Pause

4th flashing sequence          digit 10:          display shows **1**

Pause

5th flashing sequence          digit 1:          display shows **4**

After disclosing the complete figure, there is a 2 second pause, after which the procedure is repeated and the number of door cycles is displayed all over again.



## 5. Programming the extension unit Control 70

### 5.14 Menu 12: Special functions

With this menu, the following special functions can be activated:

- Central control**  
 The central control function is an optional special function. It must be programmed at the factory specifically for the customer and in the standard version of the extension unit is not in use.  
**Example of application:**  
 Control of several door systems via one central command unit, e.g. fire alarm.
- Master button**  
 If the master button operating mode is activated and a safety element (closing edge safety device, roll-up safety device) fails, the door can only be made to travel in the no longer monitored direction via a master button (see chapter 4.5, button connection-circuit board).  
**Example of application:**  
 Public door systems, avoidance of safety risks on failure of safety elements; the door system can only be operated by authorised persons, e.g. via a keyswitch.



The time phase is selected via the  $\oplus$  and  $\ominus$  buttons and stored via button  $\textcircled{P}$  in accordance with the following table.

Display	Function
0*	No special function
1	Central control operating mode
2	Master button operating mode

\* Factory setting

## 4. Connection and Initial Operation of Accessories



### Connecting the photocell

Special 613, item no. 153 550  
 Special 614, item no. 152 675  
 Special 615, item no. 152 703

Connect the photocell to socket **X20** (p. 2, pos. 5) in the control unit. Cabling of the photocell is carried out as shown below. Details can be found in the installation instructions supplied with the photocell.

Programming of the external photocell is carried out as described in chapter 5.9, menu 7 and chapter 5.10, menu 8.

**Connection plan** for external photocell:

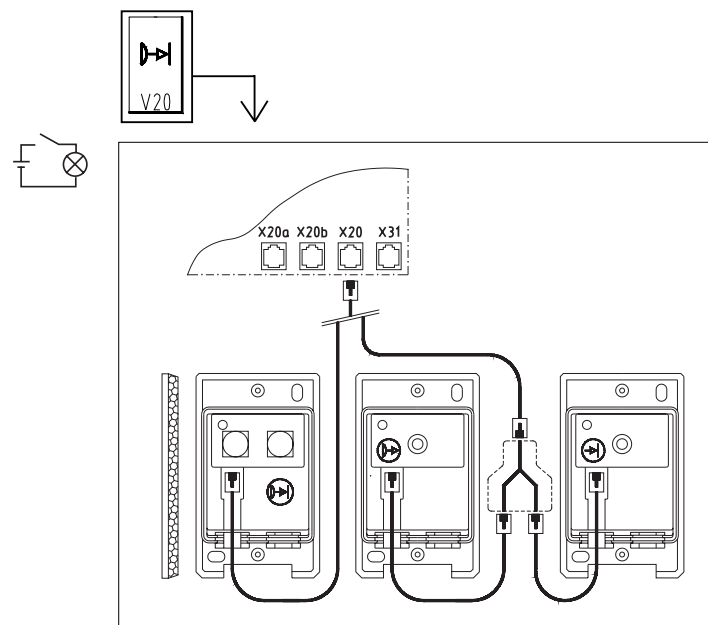

### Operational check:

- Operate the door to travel in the CLOSE direction.
- Interrupt the light path of the photocell

⇒ **The door should stop and then re-open (the function depends on the programmed operating mode).**  
 If this is not the case, refer to the test instructions in the documentation supplied with the external photocell.

## 4. Connection and Initial Operation of Accessories

### 4.4 Roll-up safety device (only extension unit)

Item no. 47 381

**Function:** The roll-up safety device monitors the lintel (headroom) area of the door. If the opening door encounters an obstruction in this area, the door is automatically halted.

**In the case of control units for rolling grilles, the roll-up safety device is always programmed.**

**When the door is closed, all the photocells are switched off. To adjust the roll-up safety device, you must therefore fully or partially open the door.**

#### Connecting the roll-up safety device:

Connect the roll-up safety device to socket **X20a** (p. 2, pos. 6) in the control unit. Cabling of the roll-up safety device is carried out as shown below.

**Make sure that the earth cable (see fig. below, pos. 6) is connected to the side guide.**

**Connection plan** for the roll-up safety device:

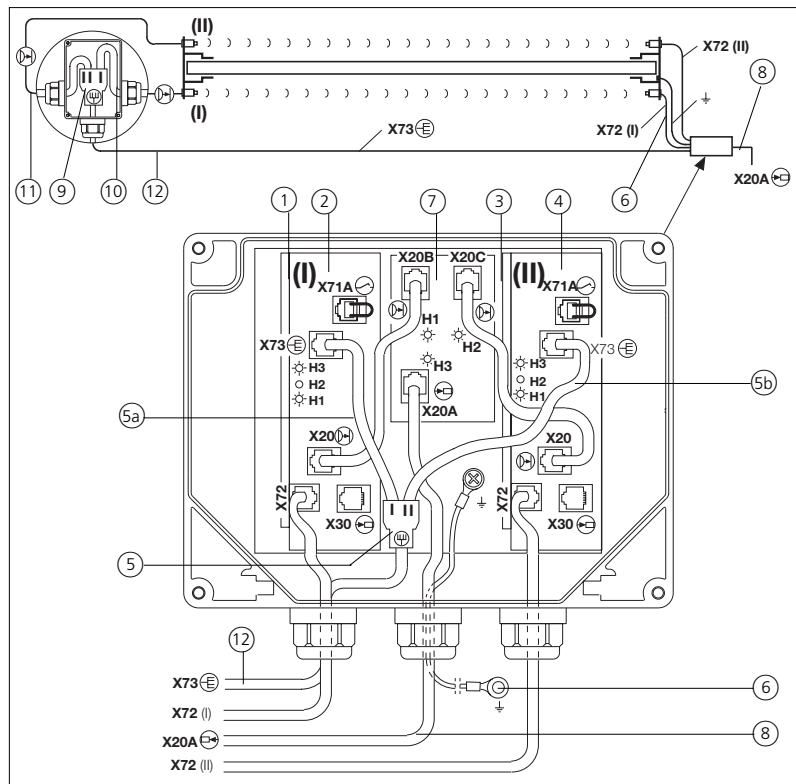

## 5. Programming the extension unit Control 70

### 5.12 Menu 10: Signal lights

For the operating mode of the signal lights you can choose between flashing light and permanent light.



The time phase is selected via the **+** and **-** buttons and stored via button **P** in accordance with the following table.

Display	Function
0	Perman. light
1*	Flashing light

\* Factory setting

### 5.13 Menu 11: Traffic lane control ON/OFF

This menu activates or deactivates the traffic lane control.

#### Note:

The traffic lane control function can only be used together with the traffic light control, Control 313, item no. 48 078 (see chapter 4.6, traffic light control).



The time phase is selected via the **+** and **-** buttons and stored via button **P** in accordance with the following table.

Display	Function
0*	Traffic lane control non-active
1	Traffic lane control active



\* Factory setting

## 5. Programming the extension unit Control 70

### 5.10 Menu 8: Response after activation of the external photocell

After activation of the external photocell to monitor the through-traffic area, four responses are possible:

- STOP, the door halts.
- SHORT REVERSE, the door halts and then opens for the duration of approx. 2 seconds.
- LONG REVERSE, the door halts and then travels to its OPEN travel limit.
- No response, no photocell is fitted.

The time phase is selected via the  und  buttons and stored via button  in accordance with the following table.

**Note:**

Value 4, automatic timer without photocell, can only be selected via the  button.



Display	Function
0	Stop
1	Short reverse
2	Long reverse
3*	Photocell not fitted
4	Automatic timer without photocell

\* Factory setting

### 5.11 Menu 9: Response after activation of the closing edge safety device

After activation of the closing edge safety device, three responses are possible:

- STOP, the door halts.
- SHORT REVERSE, the door halts and then closes to clear the obstruction - duration approx. 2 seconds.
- LONG REVERSE, the door halts and then opens to its OPEN travel limit to clear the obstruction.

The time phase is selected via the  und  buttons and stored via button  in accordance with the following table.

Display	Function
0	Stop
1*	Short reverse
2	Long reverse

\* Factory setting

## 4. Connection and Initial Operation of Accessories

### Legend (electronics housing):

- Electronics circuit board (I)
  - X72 Connection socket, receiver
  - H1 green LED: Voltage
  - H2 yellow LED: Function indicator, static current circuit (if included)
  - H3 red LED: Function indicator, glows when light path clear (I)
- Standard base circuit board (I)
  - X73 Connection socket, receiver (1)
  - X71A Connection socket, static current circuit (if included)
  - X20 Connection socket, output
- Electronics circuit board (II)
  - X72 Connection socket, receiver
  - H1 green LED: Voltage
  - H2 yellow LED: Function indicator, static current circuit (if included)
  - H3 red LED: Function indicator, glows when light path clear (II)
- Standard base circuit board (II)
  - X73 Connection socket, transmitter (I)
  - X71A Connection socket, static current circuit (if included)
  - X20 Connection socket, output
- Adapter for transmitters (I) and (II) (item no. 8 007 928)
- 5a. Connection cable (system cable) for transmitter (I)
- 5b. Connection cable (system cable) for transmitter (II)
6. Earth cable to side guide (door frame)
7. LS (photocell) circuit board - expander
  - H1 red LED - function indicator, input (I)
  - H2 red LED - function indicator, input (II)
  - H3 red LED - function indicator, output
  - X20A Output LS - expander
  - X20B Input (I) LS - expander
  - X20C Input (II) LS - expander
8. Connection cable to control unit

### Legend (transmitter housing):

- Adapter for transmitters (I) and (II)
- Transmitter I
- Transmitter II
- Connection cable electronics housing - transmitter housing

### Operational check:

- Operate the door to travel in the OPEN direction.
- Interrupt the light path of the photocell  
⇒ **The door should come to a halt.**  
If this is not the case, refer to the test instructions in the documentation supplied with the roll-up safety device.



## 4. Connection and Initial Operation of Accessories

### 4.5 Button connection circuit board

Item no. 153 126

The button connection circuit board allows the actuation of special functions. Various buttons and switches can be connected for this purpose.



**Wiring diagram detail** of button connection circuit board

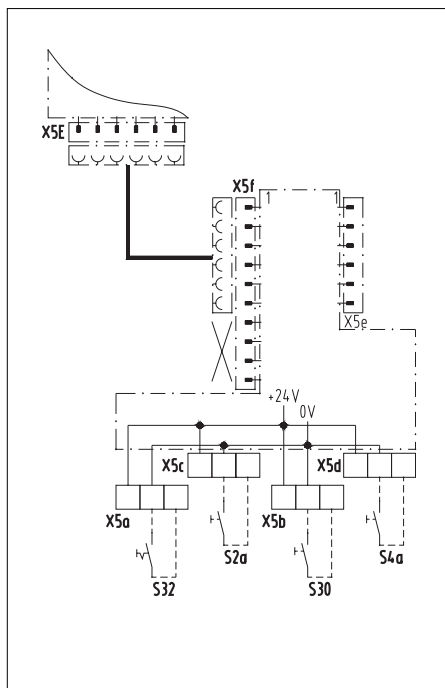

#### Legend

##### Plug connections:

- X5E Button connection circuit board (extension unit)
- X5e Button extension (additional button connection circuit board)
- X5f Button connection circuit board

##### Terminals:

- X5a Automatic ON/OFF, switching off the automatic timer, e.g. in conjunction with a timer.
- X5b IMPULSE
- X5c OPEN/master OPEN
- X5d CLOSE/master CLOSE

##### Switches:

- S2a OPEN/master OPEN
- S4a CLOSE/master CLOSE
- S30 IMPULSE
- S32 Automatic ON/OFF

----- site cabling

#### Note:

It may be necessary for you to add a small system housing with subrack (item no. 153 220) to the control unit housing.

An impulse given without any directional assignment (button connection circuit board, terminal X5b, base circuit board, terminal X2c) triggers the following responses, dependent on the position of the door:

- The door has **not** reached its end of travel OPEN position  
⇒ The door travels in the OPEN direction.
- The door has reached its end of travel OPEN position  
⇒ The door travels in the CLOSE direction.

## 5. Programming the extension unit Control 70

### 5.8 Menu 6: Start-up warning

If the start-up warning is activated, the signal lights flash for the set time phase prior to the door moving.



The time phase is selected via the ⊕ and ⊖ buttons and stored via button Ⓟ in accordance with the following table.

Display	Start-up warning in seconds
0*	0
1	1
2	2
3	3
4	4
5	5
6	6
7	7

\* Factory setting

### 5.9 Menu 7: Closing after passing the external photocell

If this function is activated and the automatic timer switched on, the opened door closes after the set OPEN PHASE or earlier after driving past the through-traffic photocell.



The time phase is selected via the ⊕ and ⊖ buttons and stored via button Ⓟ in accordance with the following table.

Display	Closing after passing the external photocell
0*	No
1	Yes

\* Factory setting

## 5. Programming the extension unit Control 70

### 5.7 Menu 4: Automatic timer "OPEN PHASE" Menu 5: Automatic timer "WARNING PHASE"

If the automatic timer is switched on, an open door is kept open for the duration of the OPEN PHASE and automatically closed after the WARNING PHASE has elapsed.

The automatic timer function can only be operated if

- an external photocell to monitor the through-traffic area is connected to the control unit (see chapter 4.3)
- or
- in menu 8 the "automatic timer without photocell" is activated

#### Recommendation:

Operate the automatic timer together with an external photocell on account of the reduced safety risk.

The phases are selected via the ⊕ and ⊖ buttons and stored via button ⊕ in accordance with the following table.

Note: The automatic timer is switched off if the OPEN PHASE and the WARNING PHASE are both set at "0".

Display	MENU 4 OPEN PHASE in seconds	MENU 5 WARNING PHASE in seconds
0*	non-active*	non-active*
1	5	2
2	10	5
3	15	10
4	20	15
5	25	20
6	30	25
7	35	30
8	40	35
9	50	40
10	80	45
11	100	50
12	120	55
13	150	60
14	180	65
15	250	70

\* Factory setting

## 4. Connection and Initial Operation of Accessories

### 4.6 Traffic light controls Control 313

Item no. 48 078

The traffic light controls Control 313 regulate the incoming and outgoing traffic with the aid of red-green traffic lights. The OPEN and WARNING phases are set via the menus 4 and 5, chapter 5.7.

#### Connecting the traffic light controls

Connect the control unit to the circuit boards and flat cables included in the supply package of the traffic light controls:

Relay circuit board 1 (item no. 153 112): plug connection **X4b**  
Control unit: plug connection **X8b**  
Relay circuit board 2 (item no. 152 116): plug connection **X4**  
Control unit: plug connection **X8c**  
Button connecting circuit board: plug connection **X5f**  
Control unit: plug connection **X5E**

Always attach the flat-cable plugs so that the cable is angled in the direction of the circuit board edge.

Wiring diagram detail of traffic light controls:

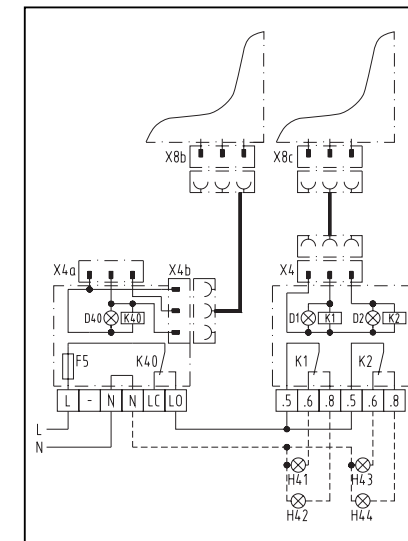
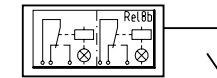

#### Legend:

D1 EXIT control light  
D2 ENTRY control light  
D40 SIGNAL LIGHTS control light  
F5 Mains fuse (max. 4A)  
H41 EXIT signal light (red)  
H42 EXIT signal light (green)  
H43 ENTRY signal light (red)  
H44 ENTRY signal light (green)  
K1 EXIT relay  
K2 ENTRY relay  
K40 SIGNAL LIGHTS relay

#### Plug connections

X4 Relay triggering  
X4a Relay triggering  
X4b Relay triggering  
X8b Signal lights relay (in the control unit)  
X8c Traffic lane control relay (in the extension unit)

----- site cabling



## 4. Connection and Initial Operation of Accessories



Wiring diagram detail of button connection - traffic light controls circuit board

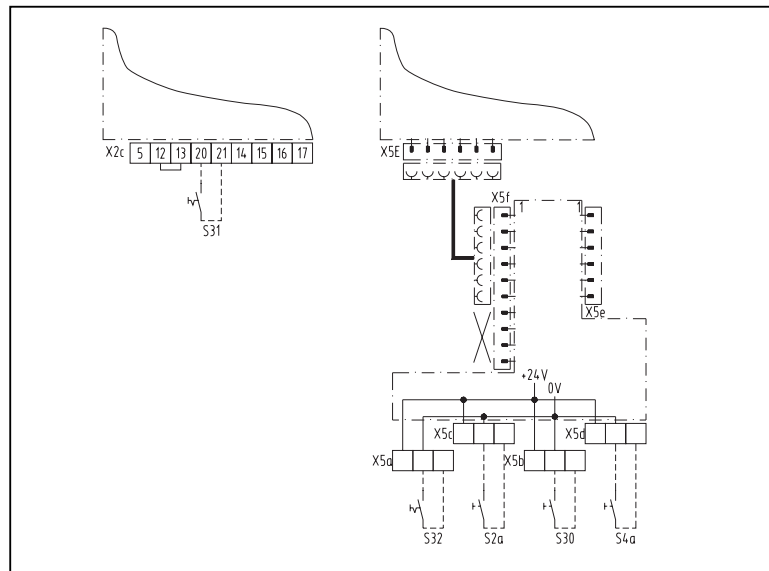
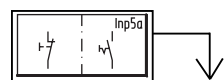

### Legend

#### Plug connections:

- X5E** Button connection-circuit board (extension unit)
- X5e** Button extension (additional button connecting circuit board)
- X5f** Button connection-circuit board

#### Terminals:

- X5a** Automatic ON/OFF, switching off of the automatic timer, e.g. in conjunction with a time switch.
- X5b** EXIT impulse
- X5c** OPEN impulse/OPEN master
- X5d** CLOSE impulse/CLOSE master

#### Switches:

- S2a** OPEN impulse/OPEN master
- S4a** CLOSE impulse/CLOSE master
- S30** EXIT impulse
- S31** ENTRY impulse
- S32** Automatic ON/OFF

----- site cabling

## 5. Programming the extension unit Control 70

### 5.5 Menu 2: Operating modes "OPEN/CLOSE press-and-release"

For every operational direction of the door, the operating mode "PRESS-AND-HOLD" (DEAD MAN'S CONTROL) or "PRESS-AND-RELEASE" can be selected.

The operating modes are selected via the ⊕ and ⊖ buttons and stored via button P according to the following table.

Display	OPEN direction	CLOSE direction
0	Dead man's control	Dead man's control
1	Press-and-release	Dead man's control
2	Dead man's control	Press-and-release
3*	Press-and-release	Press-and-release

\* Factory setting



### 5.6 Menu 3: Operating modes "button functions"

Selection of the STOP function for the control elements. The function can be selected separately for impulse and direction buttons. If the STOP function is activated, operating the control element halts a moving door.

The operating modes are selected via the ⊕ and ⊖ buttons and stored via button P according to the following table:

Display	Direction buttons		Impulse button	
	No stop	Stop	No stop	Stop
0*	X		X	
1	X			X
2		X	X	
3		X		X

\* Factory setting



## 5. Programming the extension unit Control 70

### 5.4 Menu 1: Storing the transmitting code/ remote control with system plug

**Note:**

Menu 1 can only be used in conjunction with the electronic aerial Digital 162, item no. 151 198 and the hand transmitters Digital 101- Digital 104 or Digital 121- Digital 124!

Menu 1 allows the:

- reading in
- storage
- deletion

of the transmitting codes of hand transmitters.

If the traffic light control (menu 11) is activated, two hand transmitter codes can be read in:

**Storage location 0:** transmitting code for the ENTRY radio signal  
**Storage location 1:** transmitting code for the EXIT radio signal

If the traffic light control is not activated, only storage location 0 can be used.

1. Select menu 1 via the **+** or **-** buttons.
2. Open the programme by pressing button **P**:

A "0" (zero) appears in the display:

**Slow flashing** => transmitting code is stored.

**Rapid flashing** => no transmitting code is stored.

3. Release button **P** and carry out one of the following operations.

**Reading-in and storing a transmitting code:**

- Press button **P** for longer than 2 but no longer than 5 seconds. The display flashes slowly.
- Release button **P**.
- Press the corresponding button of the hand transmitter until the display flashes rapidly.  
=> The transmitting code is now stored

**Deleting the transmitting code:**

- Press button **P** for longer than 5 seconds. The display first flashes slowly and then rapidly.  
=> The transmitting code is now deleted.

**Closing the menu:**

- Press button **P** for less than 2 seconds. The display glows for as long as button **P** is pressed.



## 5. Programming the extension unit Control 70

### 5.1 General information



The extension unit Control 70 features a display screen to show status and error messages as well as to display menu numbers and menu contents of the programming menus.

The programming menus make it possible to:

- programme **performance features** of the Control 70
- give out detailed **error numbers**.

The programming functions are controlled via the **+**, **-** and **P** buttons.



The menu numbers are selected via the **+** button (next menu) and **-** button (previous menu).

The menu number appears **permanently glowing** in the display.

The selected menu is opened via button **P**.

The **set values** or **parameters** appear **flashing** in the display. The set values can be altered via the **+** and **-** buttons. The displayed value is stored and the menu closed again via button **P**.

To **quit** the programming menu, select menu 0. Menu 0 is arrived at when a status message (see chapter 5.2) appears in the display. The control unit is then in the normal operating mode

Display menu number (permanently glowing)		Display value/parameters (flashing)
<b>+</b> next menu    <b>-</b> previous menu	<b>P</b> open menu    <b>P</b> close menu and store	<b>+</b> next value    <b>-</b> previous value

**Programming principle:**

**If during the course of programming you do not press a button within 60 seconds,**

- the programming process is aborted
- you are returned to the operating mode
- an error message is displayed (error number 7)

**Press button **P** to quit the error message. Programming can then be restarted.**



## 5. Programming the extension unit Control 70

### 5.2 Display of status messages

During normal operation of the door, the following door conditions are displayed:

#### Explanation of symbols:

 - LED off

 - LED glowing

 - LED flashing

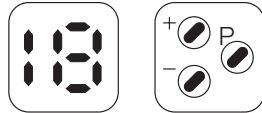

#### Displayable door conditions:



Door reached CLOSE travel limit

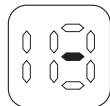

Door between end-of-travel limits

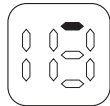

Door reached OPEN travel limit

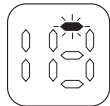

Warning phase of automatic timer

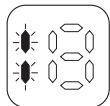

Error message:  
Displayed until the control unit's self-check (carried out prior to every door movement) no longer detects an error/fault.

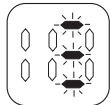

Self-check has not detected any errors/faults (appears after pressing button **P**).

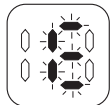

Extension unit defective

## 5. Programming the extension unit Control 70

### 5.3 Displaying the error numbers

In this menu, any occurring errors/faults are indicated. If several errors/faults have occurred, these can be called up one after the other on pressing the **+** and **-** buttons.

#### List of error numbers:

Error number	Fault characteristic
0	The <b>static current circuit</b> of the control unit has been broken: <ul style="list-style-type: none"> <li>- Control unit locked (keyswitch)</li> <li>- Static current circuit on door leaf open (optosensor)</li> <li>- STOP button actuated*</li> <li>- STOP button, terminal X2c open or jumper not inserted</li> <li>- No control element or short-circuit plug in socket X10*</li> </ul> <p>* Base circuit board</p>
5	<b>Closing edge safety device</b> actuated <ul style="list-style-type: none"> <li>- Closing edge safety device actuated whilst door closing.</li> </ul>
6	<b>Photocell</b> actuated (depends on the running direction of the operator) <ul style="list-style-type: none"> <li>- External photocell</li> <li>- Roll-up safety device</li> </ul>
7	<b>Programming mode</b> aborted: <ul style="list-style-type: none"> <li>- Programming of control unit aborted due to exceeding the programming allowance time of 60 seconds.</li> </ul>
11	<b>Excess travel stop</b> <ul style="list-style-type: none"> <li>- Door operator cut off due to excess travel stop (70 seconds)</li> </ul>
13	Faulty <b>self-check</b> on <b>closing edge safety device</b> <ul style="list-style-type: none"> <li>- No visual contact between transmitter and receiver bung</li> <li>- Bottom door seal defective</li> <li>- Closing edge safety device defective/incorrectly fitted</li> </ul>
15	Faulty <b>self-check</b> on <b>external photocell</b> or <b>roll-up safety device</b> <ul style="list-style-type: none"> <li>- No visual contact between transmitter and receiver of photocell or reflector misaligned</li> <li>- Photocell defective/incorrectly fitted</li> </ul>